



# RNAscope<sup>®</sup> HiPlex Assay

## With Sample Preparation and Pretreatment

Document Number 324100-UM



For Research Use Only. Not for diagnostic use.

### **Trademarks**

RNAscope® and HybEZ™ are trademarks of Advanced Cell Diagnostics, Inc. All other trademarks belong to their respective owners.

### **Citing RNAscope® in Publications**

When describing a procedure for publication using this product, please refer to it as the RNAscope® Assay and cite: Wang F, Flanagan J, Su N, Wang L-C, Bui S, Nielson A, Wu X, Vo H-T, Ma X-J and Luo Y. RNAscope®: A Novel *In Situ* RNA Analysis Platform for Formalin-Fixed Paraffin-Embedded Tissues. *J. Mol. Diagnostics*, 2012, 14:22–29.

### **Disclaimers**

Advanced Cell Diagnostics, Inc. reserves the right to change its products and services at any time to incorporate technological developments. This manual is subject to change without notice.

Although this manual has been prepared with every precaution to ensure accuracy, Advanced Cell Diagnostics, Inc. assumes no liability for any errors, omissions, or for any damages resulting from the use of this information.

### **Copyright**

© 2019. Advanced Cell Diagnostics, Inc. All rights reserved.

# Contents

<b>Chapter 1. Product Information .....</b>	<b>5</b>
About this guide.....	5
Product description.....	5
Background .....	5
Overview.....	5
Compatible sample types.....	6
Kit contents and storage.....	7
RNAscope® HiPlex Probes.....	7
RNAscope® HiPlex Reagent Kit .....	8
Required materials and equipment .....	9
HybEZ™ Hybridization System .....	9
User-supplied materials.....	10
 <b>Chapter 2. Before You Begin .....</b>	 <b>11</b>
Important procedural guidelines .....	11
 <b>Chapter 3. Prepare and Pretreat Samples .....</b>	 <b>12</b>
Prepare fresh, frozen sections .....	12
Materials required.....	12
Prepare the block .....	12
Section the block.....	13
Prepare the slides for the RNAscope® Assay .....	13
Workflow.....	13
Materials required.....	14
Fix the sections .....	14
Dehydrate the sections.....	14
Create a hydrophobic barrier .....	14
Materials required.....	15
Prepare the equipment .....	15
Apply Protease IV.....	15
Fixed frozen tissue sample preparation and pretreatment.....	16
Workflow.....	16
Materials required.....	17
Fix samples .....	17
Freeze tissues .....	17
Prepare sections .....	18
Prepare pretreatment materials .....	18
Perform target retrieval using the Steamer .....	19
Create a barrier .....	19
Load the slides in the RNAscope® EZ-Batch™ Slide Holder .....	20
Apply RNAscope® Protease III .....	22
 <b>Chapter 4. RNAscope® HiPlex Assay .....</b>	 <b>23</b>
Workflow.....	23
Materials required for the assay .....	25

Prepare the materials .....	25
Prepare 1X Wash Buffer .....	25
Prepare 4X SSC .....	25
Prepare PBST (0.5% Tween) .....	26
Prepare probes .....	26
Equilibrate reagents .....	26
Run the assay .....	26
Hybridize probe .....	26
Hybridize RNAscope® HiPlex Amp 1 .....	27
Hybridize RNAscope® HiPlex Amp 2 .....	27
Hybridize RNAscope® HiPlex Amp 3 .....	27
Hybridize RNAscope® HiPlex Fluoro T1–T4 .....	28
Counterstain and mount the slides .....	28
Image the slides for Round 1 .....	28
Equilibrate reagents .....	29
Cleave the fluorophores .....	29
Hybridize RNAscope® HiPlex Fluoro T5–T8 .....	29
Mount the slides .....	30
Image the slides for Round 2 .....	30
Image registration using RNAscope® HiPlex Registration Software .....	30
Continue with 12-plex detection using the 12Plex Ancillary Kit .....	30
Cleave the fluorophores .....	30
Hybridize RNAscope® HiPlex Fluoro T9–T12 .....	31
Counterstain and mount the slides .....	31
Image the slides for Round 3 .....	32
Image registration using RNAscope® HiPlex Registration Software .....	32
Evaluate the samples .....	33
Fluorescent Imaging Recommendations .....	33
Control example .....	34
Troubleshooting .....	34
<b>Appendix A. Reagent Volume Guidelines .....</b>	<b>35</b>
Determine reagent volume .....	35
<b>Appendix B. Manual Target Retrieval .....</b>	<b>36</b>
Materials required .....	36
Prepare 1X RNAscope® Target Retrieval Reagents .....	36
Apply RNAscope® Target Retrieval Reagents .....	36
<b>Appendix B. Safety .....</b>	<b>37</b>
Chemical safety .....	37
Biological hazard safety .....	37
<b>Documentation and support .....</b>	<b>39</b>
Obtaining SDSs .....	39
Obtaining support .....	39
Contact information .....	39
Limited product warranty .....	39

# 1

## Chapter 1. Product Information



Before using this product, read and understand the information in **Appendix C. Safety** on page 37 in this document.

---

**Note:** We recommend reading the entire user manual before beginning any protocols.

---

### About this guide

This user manual provides guidelines and protocols to use the RNAscope® HiPlex8 Detection Kit (Cat. No. 324100) and the RNAscope® HiPlex12 Ancillary Kit (Cat. No 324120) on fresh and fixed frozen sections mounted on slides.

Visit [www.acdbio.com/technical-support/user-manuals](http://www.acdbio.com/technical-support/user-manuals) to download a sample preparation user guide or technical note for other sample types.

### Product description

#### Background

The RNAscope® HiPlex Assay uses a novel and proprietary method of *in situ* hybridization (ISH) to simultaneously visualize up to 12 different RNA targets per cell in samples mounted on slides. Simultaneous detection of up to 12 different RNA targets requires combining the RNAscope® HiPlex8 Detection Kit, which detects up to eight targets, with the RNAscope® HiPlex12 Ancillary Kit.

The assay is based on ACD's patented signal amplification and background suppression technology and incorporates multiplexed signal amplification systems, which enable users to investigate expression as well as positional relationship between multiple genes within a cellular context.

#### Overview

See **Figure 1** on page 6 for an illustration of the assay.

RNAscope® HiPlex Assay reagents are provided in convenient Ready-To-Use dropper bottles allowing a simple, nearly pipette-free workflow. Properly prepared samples are first pretreated, and then RNA-specific probes designed for different detection tails/channels are hybridized to multiple RNAs (up to 12 RNA targets). After a series of highly effective and specific signal amplifications, single RNA transcripts for up to four target genes at a time can be visualized as punctate dots in four distinct fluorescent channels using the cleavable versions of the fluorophores AF488, Atto550, Atto647 and AF750. These dots are visible with an epifluorescence microscope and the appropriate filters. After imaging, the fluorophores from the first four targets are cleaved off and the next four targets are labeled and imaged. Images from the various rounds can

be merged together using the RNAscope® HiPlex Registration Software (refer to the *RNAscope® HiPlex Image Registration Software User Manual/Doc. No. 300065-USM*). The RNAscope® HiPlex12 Ancillary Kit (Cat. No. 324120) allows you to perform a third round of fluorescent target labeling and imaging. The target probe hybridization, signal amplification, and the first round of signal detection can be completed in 7–8 hours. Each subsequent round of signal detection requires an additional hour.

**Figure 1. Procedure overview**

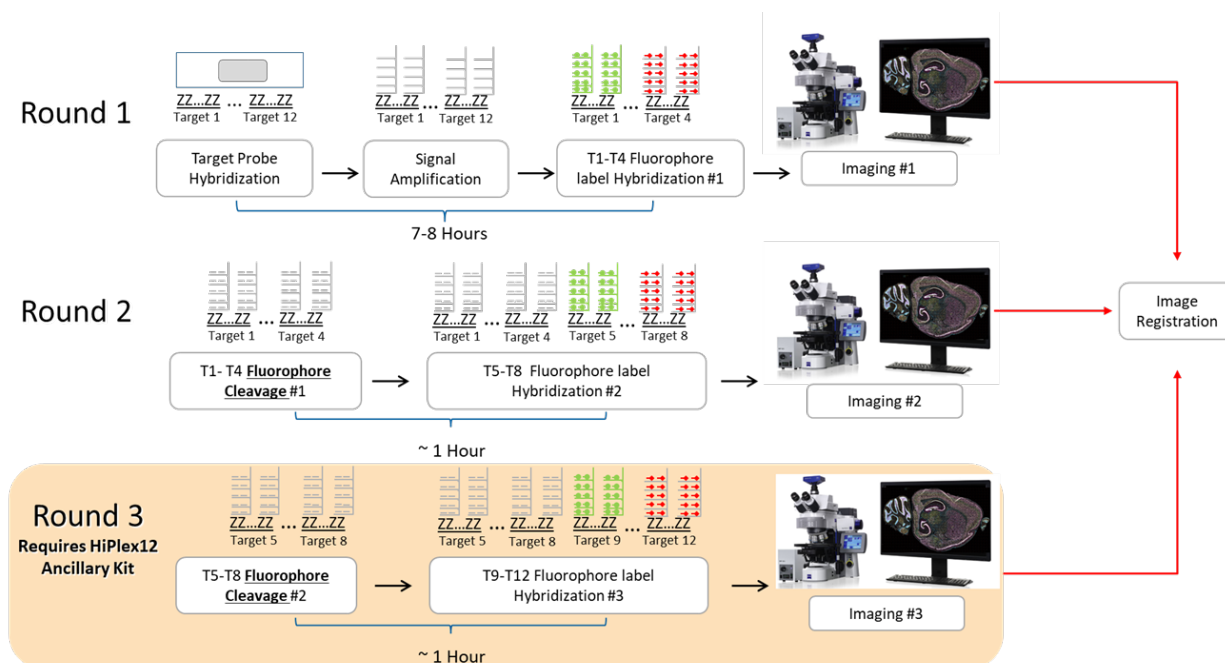

## Compatible sample types

The RNAscope® HiPlex Assay is compatible with fresh frozen (FF) tissue, cultured adherent cells on chamber slides, and fixed frozen tissue. Tissue autofluorescence in other sample types can interfere with the assay.

Use the guide below to determine the appropriate pretreatment reagent from the Universal Pretreatment Reagent Kit (Cat No. 322380) or the RNAscope® Protease III and IV Reagents (Cat. No. 322340) and RNAscope® Target Retrieval Reagents (Cat. No. 322000).

RNAscope® HiPlex Detection Pretreatment Guide		
Tissue Type	Pretreatment Kit	Pretreatment Cat. No.
Fresh Frozen	RNAscope® Protease IV	322336
Fixed Frozen	RNAscope® Target Retrieval (10X)	322001
	RNAscope® Protease III	322337
Cultured adherent cells	RNAscope® Protease III	322337

Please contact technical support at [support.acd@bio-techne.com](mailto:support.acd@bio-techne.com) if you have any questions.

## Kit contents and storage

The RNAscope® HiPlex Assay requires the RNAscope® HiPlex Probes and the RNAscope® HiPlex Reagent Kit. Probes and reagent kits are available separately.

### RNAscope® HiPlex Probes

The RNAscope® HiPlex Probes consist of user-specified Target Probes and Positive and Negative Control Probes. Visit <https://acdbio.com/products> to find a gene-specific target probe. Visit <http://www.acdbio.com/control-slides-and-probes> to order appropriate control probes. Each target probe contains a mixture of short oligonucleotides designed to bind to a specific target RNA and is detectable in one of four color channels specified in the following table:

Detection (3 rounds)	Probe Tail/Channel	Fluorophore	Emission	Color
Round 1	T1	Alexa Fluor 488	520 +/- 10nm	Green
	T2	ATTO 550	576 +/- 10nm	Orange
	T3	ATTO 647N	670 +/- 10nm	Far Red
	T4	Alexa Fluor 750	775 +/- 10nm	Near IR
Round 2	T5	Alexa Fluor 488	520 +/- 10nm	Green
	T6	ATTO 550	576 +/- 10nm	Orange
	T7	ATTO 647N	670 +/- 10nm	Far Red
	T8	Alexa Fluor 750	775 +/- 10nm	Near IR
Round 3	T9	Alexa Fluor 488	520 +/- 10nm	Green
	T10	ATTO 550	576 +/- 10nm	Orange
	T11	ATTO 647N	670 +/- 10nm	Far Red
	T12	Alexa Fluor 750	775 +/- 10nm	Near IR

You can select different combinations of targets in the RNAscope® HiPlex assay. Each target probe must be assigned to a different probe channel (T1–T12). All RNAscope® HiPlex probes are shipped as 50X concentrated stocks and need to be diluted in RNAscope® HiPlex Probe Diluent (Cat. No. 324301). For example, to make 200 µL of solution containing all 12 probes, use 4 µL of each probe stock and add 152 µL of RNAscope® HiPlex Probe Diluent.

**Note:** Do not use RNAscope® HiPlex probes for **ANY** other RNAscope® assays.

Each probe is sufficient for staining ~10 sections, each with an area of approximately 20 mm x 20 mm (0.75" x 0.75"). Larger tissue sections will result in fewer tests. The probes have a shelf life of two years from the manufacturing date when stored as indicated in the following tables:

Target Probes					
<input checked="" type="checkbox"/>	Reagent	Cat. No.	Content	Quantity	Storage
	Target Probe – [species]– [gene]– T1...T12	Various	50X probe	40 µL x 1 tube	2–8°C

Control Probes					
<input checked="" type="checkbox"/>	Reagent	Cat. No.	Content	Quantity	Storage
	RNAscope® HiPlex12 Positive Control Probe-Mm	324321	RTU mixture of 12 probes targeting housekeeping gene Polr2a, PPIB, Ubc, Hprt, Actb, Tubb3, Bin1, Ldha, Gapdh, Pgk1, Bhlhe22, and Cplx2 with T1- T12 tails respectively in each of the 12 channels.	2 mL x 1 bottle	2–8°C
	RNAscope® HiPlex12 Positive Control Probe-Hs	324311	RTU mixture of 12 probes targeting housekeeping gene Polr2a, PPIB, UBC, HPRT1, TUBB, RPL28, RPL5, B2M, ACTB, LDHA-O1, RPLP0-X-RPLPOP2, and GAPDH with T1- T12 tails respectively in each of the 12 channels.	2 mL x 1 bottle	2–8°C
	RNAscope® HiPlex12 Negative Control Probe	324341	RTU probe targeting a bacterial gene (dapB), Each detection channel has its own negative control probe.	2 mL x 1 bottle	2–8°C
	RNAscope® HiPlex Probe Diluent	324301	RTU probe diluent	2 mL x 1 bottle	2–8°C

## RNAscope® HiPlex Reagent Kit

Each RNAscope® HiPlex Detection Kit (both Cat. No. 324110 and 324120) provides enough reagents to stain ~20 tissue sections, each with an area of approximately 20 mm x 20 mm (0.75" x 0.75"). Larger tissue sections will result in fewer tests. Please refer to the tables below for the contents of the sub-kits Pretreatment Kit, Detection Kit, and Wash Buffer Kit etc.

The reagents have a shelf life of nine months from the manufacturing date when stored as indicated in the following tables:

Pretreatment Reagents (Cat. No. 322340)			
<input checked="" type="checkbox"/>	Reagent	Quantity	Storage
	RNAscope® Protease III	4.5 mL x 1 bottle	2–8°C
	RNAscope® Protease IV	4.5 mL x 2 bottles	2–8°C
Detection– RNAscope® HiPlex8 Detection Kit (Cat. No. 324110)			
<input checked="" type="checkbox"/>	Reagent	Quantity	Storage
	RNAscope® HiPlex Amp 1	3 mL x 1 bottle	2–8°C
	RNAscope® HiPlex Amp 2	3 mL x 1 bottle	2–8°C
	RNAscope® HiPlex Amp 3	3 mL x 1 bottle	2–8°C
Detection– RNAscope® HiPlex8 Detection Kit (Cat. No. 324110)			
<input checked="" type="checkbox"/>	Reagent	Quantity	Storage
	RNAscope® Fluoro T1–T4	4.5 mL x 1 bottle	2–8°C
	RNAscope® Fluoro T5–T8	4.5 mL x 1 bottle	2–8°C
	RNAscope® DAPI	3 mL x 1 bottle	2–8°C



RNAscope® HiPlex12 Ancillary Kit (Cat. No. 324120)			
<input checked="" type="checkbox"/>	Reagent	Quantity	Storage
	RNAscope® Fluoro T9–T12	4.5 mL x 1 bottle	2–8°C
	RNAscope® DAPI	3 mL x 1 bottle	2–8°C
Wash Buffer Reagents (Cat. No. 310091)			
<input checked="" type="checkbox"/>	Reagent	Quantity	Storage
	50X Wash Buffer	60 mL x 4 bottles	Room temperature (15–30°C)
Cleaving Reagents (Cat. No. 324130)			
<input checked="" type="checkbox"/>	Reagent	Quantity	Storage
	RNAscope® HiPlex Cleaving Stock Solution	1.5 mL x 5 ampoules	Room temperature (15–30°C)

**Note:** Do not interchange the reagent components of the reagent kits, even those having the same name.

## Required materials and equipment

The following materials and equipment are needed to perform the RNAscope® HiPlex Assay.

### HybEZ™ Hybridization System

**Note:** The RNAscope® Assay has been qualified using this system only.

Use the HybEZ™ II Hybridization System to perform RNAscope® HiPlex Assay hybridization and incubation steps. These steps require humid conditions to prevent sections from drying out.

For instructions on how to use the HybEZ™ II Hybridization System, refer to the *HybEZ™ II Hybridization System User Manual* (Doc. No. 321710-USM) available at [www.acdbio.com/technical-support/user-manuals](http://www.acdbio.com/technical-support/user-manuals) and view the training video at [www.acdbio.com/technical-support/learn-more](http://www.acdbio.com/technical-support/learn-more). The system contains the following components:

<input checked="" type="checkbox"/>	Component	Quantity	Cat. No.
	HybEZ™ II Oven (110 or 220 VAC)	1 oven	321710 or 321720
	HybEZ™ Humidity Control Tray (with lid)	1 tray	310012
	ACD EZ-Batch™ Wash Tray		321717
	ACD EZ-Batch™ Slide Holder		321716
	HybEZ™ Humidifying Paper	2 sheets	—

**Note:** To order HybEZ™ Humidifying Paper Pack, 15 sheets, use Cat. No. 310015

## User-supplied materials

☑	Description	Supplier	Cat. No.
	ProLong Gold Antifade Mountant	Fisher Scientific/MLS*	P36930
	10X PBS	Fisher Scientific/MLS*	BP3991
	10% Tween-20	Fisher Scientific/MLS*	PI85115
	20X SSC	Fisher Scientific/MLS*	BP1325
	Tissue-Tek® Vertical 24 Slide Racks	American Master Tech Scientific/MLS	LWS2124
	Tissue-Tek® Staining Dishes	American Master Tech Scientific/MLS	LWS20WH
	Coverslips	Fisher Scientific/MLS	12-545-F
	Carboy (>3L)	MLS	—
	Water bath or incubator, capable of holding temperature at 40 +/- 1°C	MLS	—
	Distilled water	MLS	—
	Tubes (various sizes)	MLS	—
	Paper towel or absorbent paper	MLS	—
	Fluorescent microscope with filter set: <ul style="list-style-type: none"> <li>• Ex 358 nm/Em 461 nm (DAPI)</li> <li>• Ex 501 nm/Em 523 nm (FITC)</li> <li>• Ex 554 nm/Em 576 nm (Cy3)</li> <li>• Ex 644 nm/Em 669 nm (Cy5)</li> <li>• Ex 740 nm/Em 764 nm (Cy7)</li> </ul>	MLS	—

\* Major Laboratory Supplier in North America. For other regions, please check Catalog Numbers with your local lab supplier.

# 2

## Chapter 2. Before You Begin

Prior to running the RNAscope® Assay on your samples for the first time, we recommend that you View the video demonstrations available at [www.acdbio.com/technical-support/learn-more](http://www.acdbio.com/technical-support/learn-more).

### Important procedural guidelines

- Start with properly prepared sections. Refer to our sample preparation and pretreatment user guides available at [www.acdbio.com/technical-support/user-manuals](http://www.acdbio.com/technical-support/user-manuals). Use only samples mounted on SuperFrost Plus® Slides (Fisher Scientific; Cat. No. 12-550-15).
- Follow the recommended pretreatment conditions for your sample. Refer to our sample preparation and pretreatment user guides available at [www.acdbio.com/technical-support/user-manuals](http://www.acdbio.com/technical-support/user-manuals).
- Always run positive and negative control probes on your sample to assess sample RNA quality and optimal permeabilization.
- Do *not* substitute required materials. Assay has been validated with these materials only.
- Follow the protocol exactly for best results.
- Do not let your sections dry out during the procedure.
- Use good laboratory practices and follow all necessary safety procedures. Refer to **Appendix C. Safety** on page 37 for more information.

# 3

## Chapter 3. Prepare and Pretreat Samples

Fresh, frozen sample preparation and pretreatment are described in the following protocol. For other sample types and preparation methods, contact [support.acd@bio-techne.com](mailto:support.acd@bio-techne.com) for the latest protocols and guidelines.

---

**Note:** We highly recommend following these guidelines. We cannot guarantee assay results with other preparation methods.

---

### Prepare fresh frozen sections

#### Materials required

- 
- Scalpel
  - Forceps
  - Cryo-embedding medium (OCT)
  - Dry ice, liquid nitrogen, or isopentane
  - Cryostat
  - Slide boxes
  - SuperFrost® Plus slides
  - Aluminum foil or zip-lock bags
- 

#### Prepare the block

1. Remove the tissue and cut to fit into cryomolds.

---

 **CAUTION!** Handle biological specimens appropriately.

---

2. Freeze the specimen on dry ice or in liquid nitrogen within **5 MIN** of tissue harvest.
3. Embed frozen tissue in cryo-embedding medium (OCT):
  - a. Add two drops of OCT into a cryomold.
  - b. Place the frozen tissue on the OCT in the correct orientation for cutting.
  - c. Add more OCT to fill the cryomold. Do not allow any air bubbles to form.
  - d. Hold the block with forceps on the surface of liquid nitrogen or isopentane cooled by dry ice or liquid nitrogen or place the cryomold on dry ice.
4. Store the frozen block in an airtight container at **-80°C** prior to sectioning.

**Note:** Embedded tissue may be stored for up to three months.

## Section the block

1. Equilibrate block to **-20°C** in a cryostat **~1 HR.**
2. Cut **10–20 µm** sections and mount onto **SUPERFROST® PLUS SLIDES.**
3. Keep the sections at **-20°C** to dry for **~1 HR.**
4. Store the sections in slide boxes wrapped airtight with aluminum foil or zip-lock bags at **-80°C** until use.

**Note:** Sections may be stored for up to three months.

**Note:** Do not fix the slides prior to this step.

---

OPTIONAL STOPPING POINT (1). Use sectioned tissue within three months.

---

## Prepare the slides for the RNAscope® Assay

### Workflow

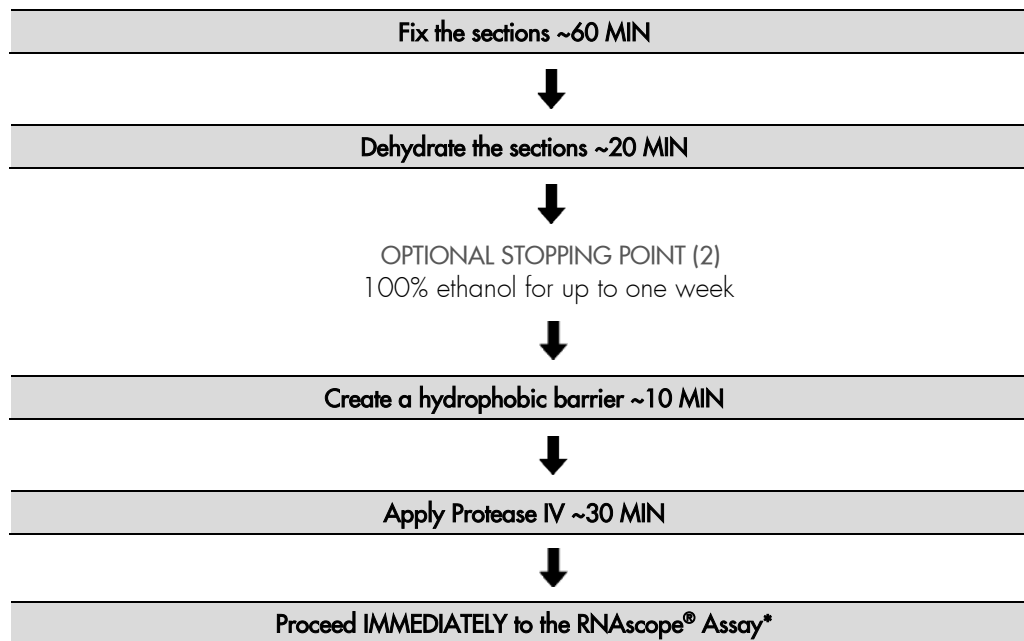

## Materials required

---

- 1X PBS
  - 10% neutral buffered formalin (NBF) or 4% paraformaldehyde (PFA)
  - 100% ethanol
  - Tissue-Tek® Vertical 24 Slide Rack
  - Tissue-Tek® Staining Dishes
  - ImmEdge™ Hydrophobic Barrier Pen
- 

## Fix the sections

1. Prepare 10% NBF (fresh 10% NBF or 4% PFA in 1X PBS) in a Tissue Tek® Staining Dish. **IMPORTANT:** Use **FRESH** fixatives. Do **NOT** reuse.
2. Remove the slides from **-80°C** and place in a Tissue Tek® Slide Rack.
3. *Immediately* immerse slides in fresh 10% NBF or 4% PFA in 1X PBS fixative. Fix for **60 MIN** at **RT**.
4. Wash slides with 1X PBS by moving the rack up and down 3–5 times and repeat with 1X PBS.

**Note:** Do **NOT** use 10% NBF that has been stored for more than six months, exposed to air for more than a week, or used repeatedly. This can result in suboptimal tissue fixation.

## Dehydrate the sections

Reagents may be prepared ahead of time. Ensure all containers remain covered.

1. Prepare 200 mL 50% ethanol, 200 mL 70% ethanol, and 600 mL 100% ethanol in Tissue Tek® Staining Dishes.
2. Place the slides in 50% ethanol for **5 MIN** at **ROOM TEMPERATURE (RT)**.
3. Place the slides in 70% ethanol for **5 MIN** at **RT**.
4. Place the slides in 100% ethanol for **5 MIN** at **RT**.
5. Repeat step 4 with fresh 100% ethanol.

---

**Note:** **OPTIONAL STOPPING POINT (2).** Slides may be stored in 100% ethanol at **-20°C** for up to **1 WEEK**. Prolonged storage may degrade sample RNA.

---

## Create a hydrophobic barrier

1. Take the slides out of 100% ethanol and place on absorbent paper with the section face-up. Air dry for **5 MIN** at **RT**.
2. Use the following template to draw a barrier 2–4 times around each section with the Immedge™ hydrophobic barrier pen. See the example on the next page.

**Note:** Refer to **Appendix A. Reagent Volume Guidelines** on page 35 to determine the recommended number of drops needed per slide.

---

**Note:** Do not let the barrier touch the section. The Immedge™ hydrophobic barrier pen is highly recommended. Other pens may result in suboptimal results.

---

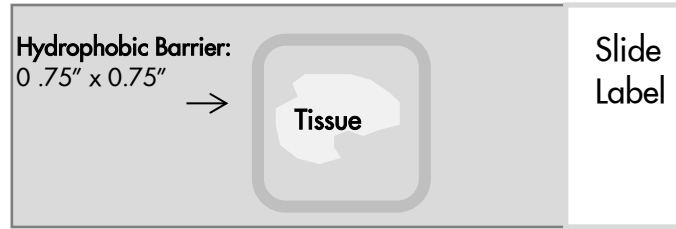

**Note:** We do not recommend drawing a smaller barrier and using less than the recommended volume, even for smaller sections. Larger barriers will result in fewer tests per kit.

1. Let the barrier dry completely **~1 MIN**.

**Note:** If you need to reapply the hydrophobic barrier during the following procedures, dry the appropriate area of the slide with a Kimwipe®. Do not touch the tissue section.

## Materials required

Materials provided by the RNAscope® Reagent Kit	Other materials and equipment
<ul style="list-style-type: none"> <li>• Protease III &amp; IV</li> </ul>	<ul style="list-style-type: none"> <li>• Prepared slides</li> <li>• Distilled water</li> <li>• Paper towel or absorbent paper</li> <li>• HybEZ™ Humidifying System/RNAscope® EZ-Batch™ Slide Holder and Tray</li> <li>• Tissue Tek® Slide Rack</li> <li>• Tissue Tek® Staining Dish</li> </ul>

## Prepare the equipment

- Turn on the HybEZ™ Oven and set the temperature to **40°C**.
- Place a Humidifying Paper in the Humidity Control Tray and wet completely with distilled water.

## Apply Protease IV

**Note:** View the wash step video at [www.acdbio.com/technical-support/learn-more](http://www.acdbio.com/technical-support/learn-more) before proceeding.

1. Load the dried slides into the RNAscope® EZ-Batch™ Slide Holder and add ~5 drops of Protease IV to entirely cover each section.
2. Incubate for **30 MIN** at **RT**.
3. Remove excess liquid from the slides by decanting and shaking the locked slides in the EZ-Batch™ Slide Holder. *Immediately* place the slide holder in the transparent EZ-Batch™ Wash Tray filled with 1X PBS.
4. Wash slides in 1X PBS with slight agitation and repeat with fresh 1X PBS.

**Note:** Slides should not stay in 1X PBS for longer than **5 MIN**.

## Fixed frozen tissue sample preparation and pretreatment

We recommend perfusing tissues with 1X PBS. For suboptimally prepared samples, you may need to optimize pretreatment conditions.

### Workflow

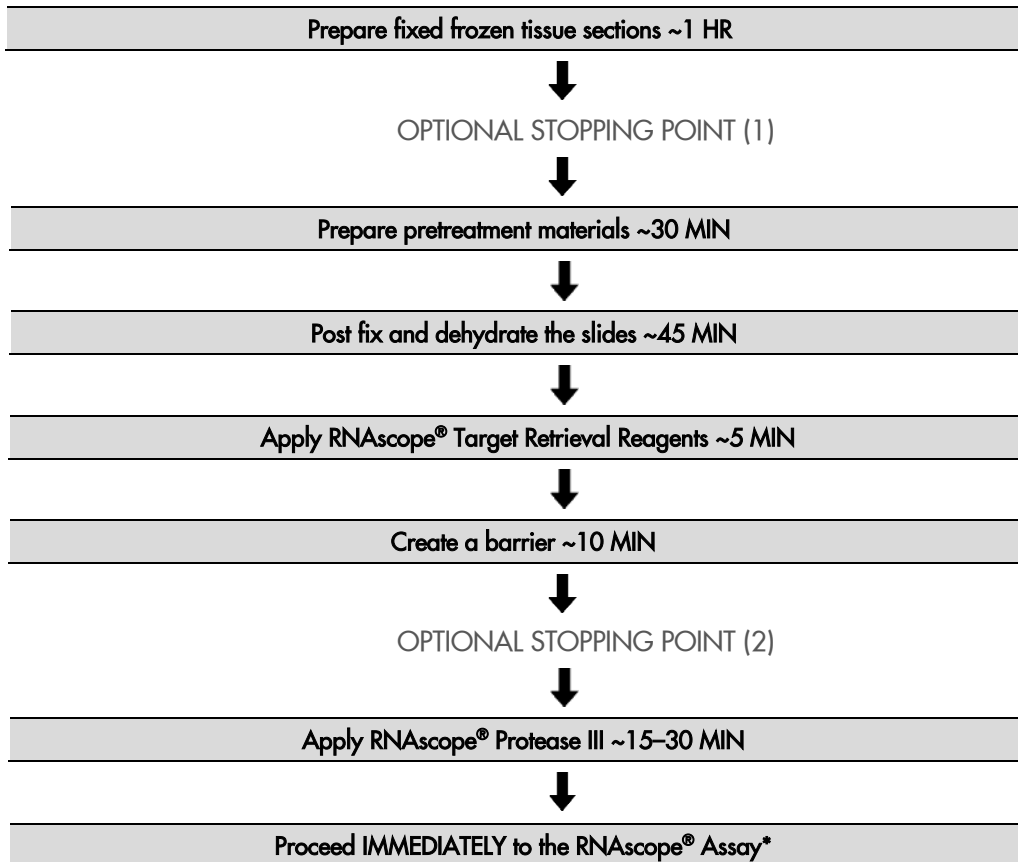



## Materials required

Materials provided by Pretreatment Reagents (Cat. No. 322340 and 322000)	Other Materials and Equipment
<ul style="list-style-type: none"> <li>• RNAscope® Protease III</li> <li>• RNAscope® 10X Target Retrieval Reagents</li> </ul>	<ul style="list-style-type: none"> <li>• Scalpel</li> <li>• Forceps</li> <li>• Cryo-embedding medium (OCT)</li> <li>• Dry ice, liquid nitrogen, or isopentane</li> <li>• Cryostat</li> <li>• Slide boxes</li> <li>• SuperFrost® Plus slides</li> <li>• Aluminum foil or zip-lock bags</li> <li>• 1X PBS</li> <li>• 10% neutral buffered formalin (NBF) or 4% paraformaldehyde (PFA)</li> <li>• 30% sucrose</li> <li>• Tissue-Tek® Vertical 24 Slide Rack</li> <li>• Tissue-Tek® Staining Dishes</li> <li>• ImmEdge™ Hydrophobic Barrier Pen</li> <li>• HybEZ™ Humidifying System/RNAscope® EZ-Batch™ Slide Holder and Tray</li> <li>• Distilled water</li> <li>• Paper towel or absorbent paper</li> <li>• Oster® Steamer</li> <li>• Digital thermometer</li> </ul>

## Fix samples

1. If needed, perfuse tissue with freshly prepared 4% paraformaldehyde (PFA) in 1X PBS, or go directly to Step 2.
2. Dissect tissue and fix in freshly prepared 10% NBF or 4% PFA for **24 HRS** at **4°C**.

## Freeze tissues

1. Immerse the tissue in 10% sucrose in 1X PBS at **4°C** until the tissue sinks to the bottom of the container (approximately **18 HRS** for brain tissue).
2. Repeat this step with 20% sucrose in 1X PBS, followed by 30% sucrose in 1X PBS, each time allowing the tissue to sink to the bottom of the container.
3. Freeze the tissue in Optimal Cutting Temperature (OCT) embedding media with dry ice or liquid nitrogen, and store it in an airtight container at **-80°C**.

## Prepare sections

1. Before tissue sectioning, equilibrate the tissue blocks at **-20°C** for at least **1 HR** in a cryostat.
2. Section the blocks by cutting 7–15 µm thick sections. Mount the sections on **SUPERFROST® PLUS SLIDES**. Place tissue as shown for optimal staining:

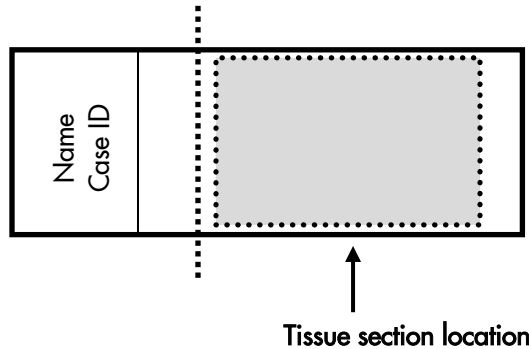

---

**Note:** Do not mount more than one section per slide. Place sections in the center of the slide.

---

3. Air dry the slides for **60 –120 MIN** at **-20°C**.

OPTIONAL STOPPING POINT (1). Use sectioned tissue within three months. Store sections with desiccants at **-80°C**.

---

4. Wash the slides with 200 mL 1X PBS in a Tissue-Tek® slide rack for **5 MIN** while moving the rack up and down to remove OCT.
5. Bake the slides for **30 MIN** at **60°C**.
6. Post-fix the slides by immersing them prechilled 10% NBF or 4% PFA in 1X PBS for **15 MIN** at **4°C**.

## Dehydrate the tissue

1. Prepare 200mL 50% EtOH, 200 mL 70% EtOH, and 400 mL of 100% EtOH.
2. Remove the slides from the 10% NBF or 4% PFA, and immerse them in 50% EtOH for **5 MIN** at **RT**.
3. Remove the slides from 50% EtOH, and immerse them in 70% EtOH for **5 MIN** at **RT**.
4. Remove the slides from 70% EtOH, and immerse them in 100% EtOH for **5 MIN** at **RT**.
5. Repeat step 4 with fresh 100% ethanol.

## Dry the slides

1. Remove the slides from 100% EtOH, and let them air dry for **5 MIN** at **RT**.

## Prepare pretreatment materials

1. Turn on the HybEZ™ Oven and set temperature to **40°C**.
2. Place a Humidifying Paper in the Humidity Control Tray and wet completely with distilled water.
3. Insert covered tray into the oven and close the oven door. Warm the tray for **30 MIN** at **40°C** before use. Keep the tray in the oven when not in use.
4. Prepare fresh RNAscope® 1X Target Retrieval Reagents by adding diluting 10X Target Retrieval Reagents, for eg add 180 mL distilled water to 20 mL of 10X stock. Mix well and scale up the volume if more buffer is needed.

## Perform target retrieval using the Steamer

We highly recommend using an Oster® Steamer for target retrieval. For an alternate method, see **Appendix B. Manual Target Retrieval** on page 36.

**Note:** You may also steam with the Braun Multiquick FS 20 Steamer or Hamilton Beach Digital Food Steamer - 5.5 Quart. For each steamer, fill the water to the maximum level before starting, and do not refill water during the steaming process.

1. Fill the water reservoir with cold tap water to the “HI” line.

---

**Note:** Do not overfill.

---



2. Place a clear Steaming Bowl onto the base.
3. Place two Tissue-Tek® staining dishes in the steam bowl. Fill one dish with 200 mL of RNAscope® 1X Target Retrieval Reagent. Fill the other dish with 200 mL of distilled H<sub>2</sub>O.
4. Turn on the steamer. Set the steamer timer by turning the black knob clockwise. Set heating time to **95 MIN**.
5. Insert a digital thermometer through the holes of the lid and into the container containing RNAscope® 1X Target Retrieval Reagent. Allow temperature to rise to at least **99°C**.
6. Add the slides to the container containing distilled H<sub>2</sub>O for **10 SEC** to acclimate the slides.
7. Remove the slides, and move them to the container containing RNAscope® 1X Target Retrieval Reagent. Cover the steamer with the lid.
8. Start the timer for **5 MIN** for mild and standard conditions.
9. Remove the slides from the steamer and transfer to a separate rinse container with 200 mL of distilled water. Allow the slides to rinse for **15 SEC**.
10. Transfer the slides to 100% alcohol for **3 MIN**.
11. Dry the slides in a **60°C** incubator (or at **RT**) for **5 MIN**.

## Create a barrier

1. Use the following template to draw a barrier 2–4 times around each section with the Immedge™ hydrophobic barrier pen.

---

**Note:** Do not let the barrier touch the section. The Immedge™ hydrophobic barrier pen is highly recommended. Other pens may result in suboptimal results.

---

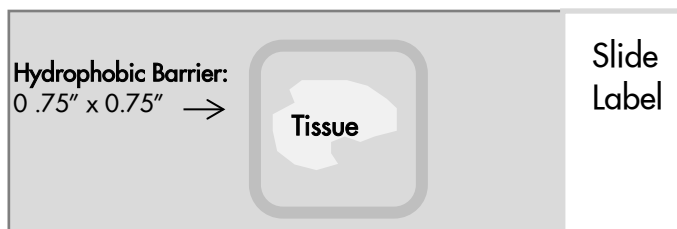

**Note:** We do not recommend drawing a smaller barrier and using less than the recommended volume amounts, even for smaller sections. Larger barriers will result in fewer tests per kit.

2. Let the barrier dry completely ~5 MIN or **OVERNIGHT** at **RT**.

**Note:** If you need to reapply the hydrophobic barrier during the following procedures, dry the appropriate area of the slide with a kimwipe. Do not touch the tissue section.

---

OPTIONAL STOPPING POINT (2). Dry the slides overnight for use the following day, or proceed directly to the next section.

---

## Load the slides in the RNAscope® EZ-Batch™ Slide Holder

The RNAscope® EZ-Batch™ Slide Holder can hold up to 20 standard glass slides in secure, lock-down positions arranged in two parallel columns. Lock-down is achieved by two lockable swing clamps, one per column, along both sides of the slide holder. Clamp locking mechanisms are located at the slots found at one end of each clamp.

1. Open the swing clamps one at a time by simultaneously squeezing (pressing and holding) the slotted portion of each clamp and rotating it up then outwards.

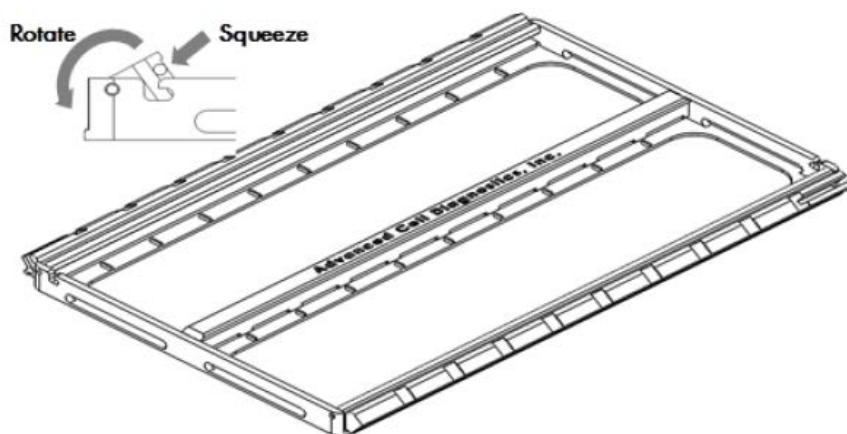

2. Insert slides one at a time into the holder (up to 10 slides per column). The **non-label** end of each slide should be aligned toward the center of the holder and inserted under the fixed clamp. Place the rest of the slide down into the holder.

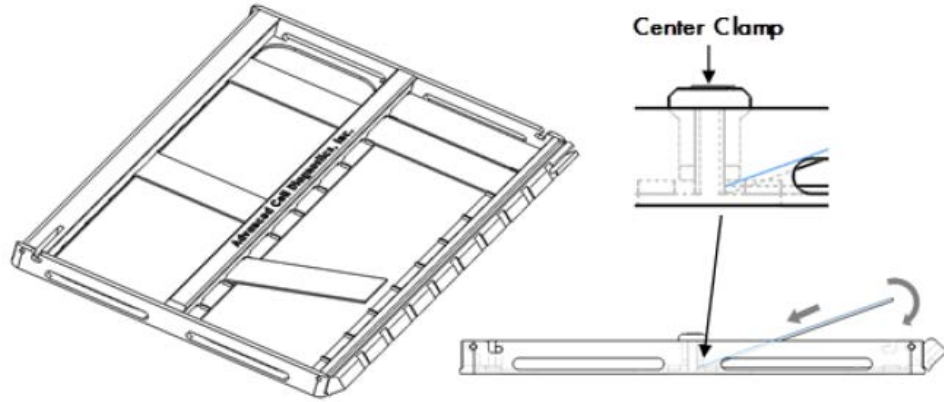

3. Close and lock the swing clamp of the column by simultaneously squeezing the slotted portion of each clamp and rotating it in then downwards in the direction opposite to the direction used to open the clamp.

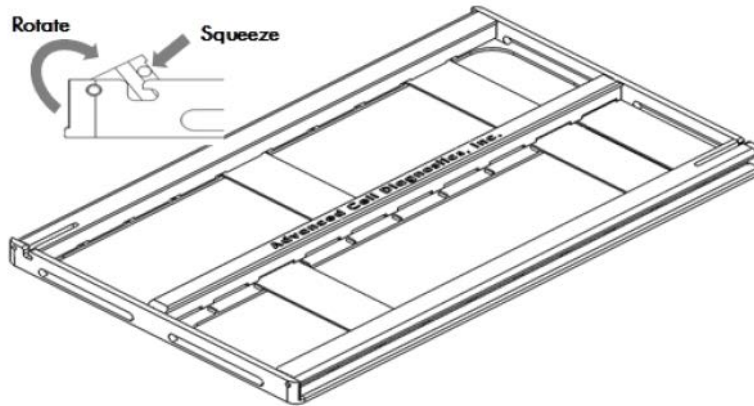

## Apply RNAscope® Protease III

1. Add ~5 drops of RNAscope® Protease III to entirely cover each section.
2. Place the RNAscope® EZ-Batch™ Slide Holder in the pre-warmed HybEZ™ Humidity Control Tray. Close the lid, seal, and insert the tray back into the oven.
3. Incubate the samples for **30 MIN** at **40°C**.

**Note:** If needed, prepare RNAscope® Assay materials during this step.

4. Pour at least 200 mL distilled water into the transparent RNAscope® EZ-Batch™ Wash Tray.
5. Remove the HybEZ™ Humidity Control Tray from the oven. Remove the slide holder from the tray. Place the tray back into the oven.
6. Place the RNAscope® EZ-Batch™ Slide Holder into the wash tray containing water. Make sure all the slides are submerged. If needed, carefully add more water. Wash the slides with slight agitation.

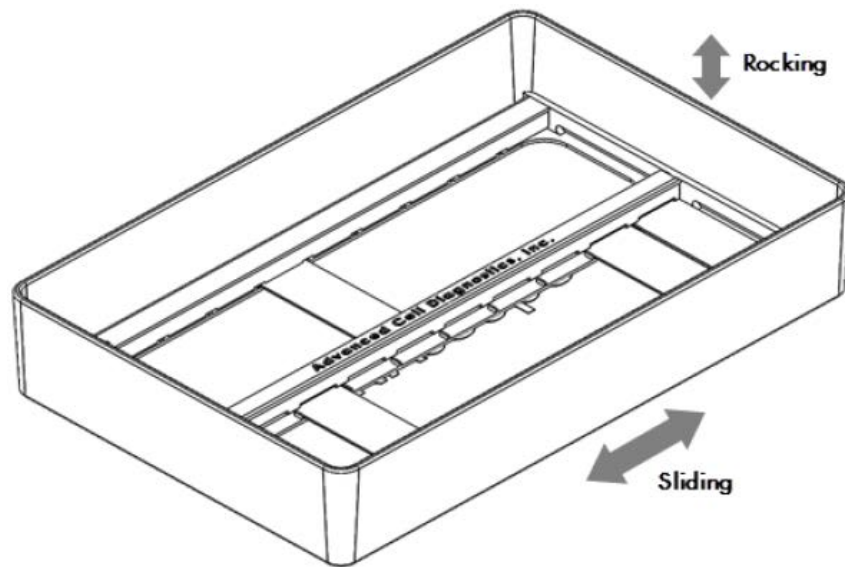

7. Repeat the wash step with fresh distilled water.
8. Proceed *immediately* to the next chapter.

# 4

## Chapter 4. RNAscope® HiPlex Assay

This procedure flows directly from sample preparation and pretreatment. Refer to **Chapter 3. Prepare and Pretreat Samples** on page 12, or the appropriate sample preparation and pretreatment user manual or technical note for your specific sample type.

### Workflow

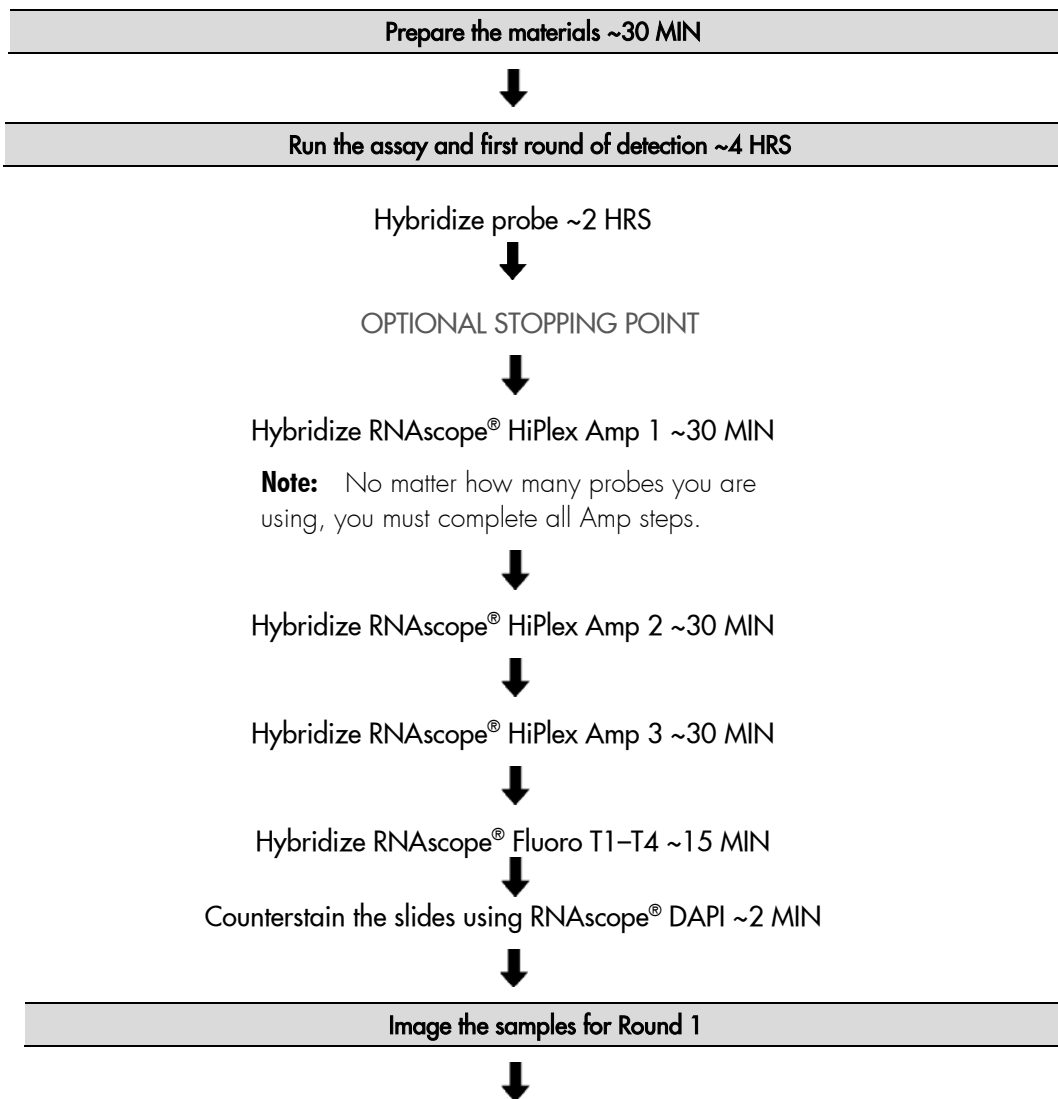

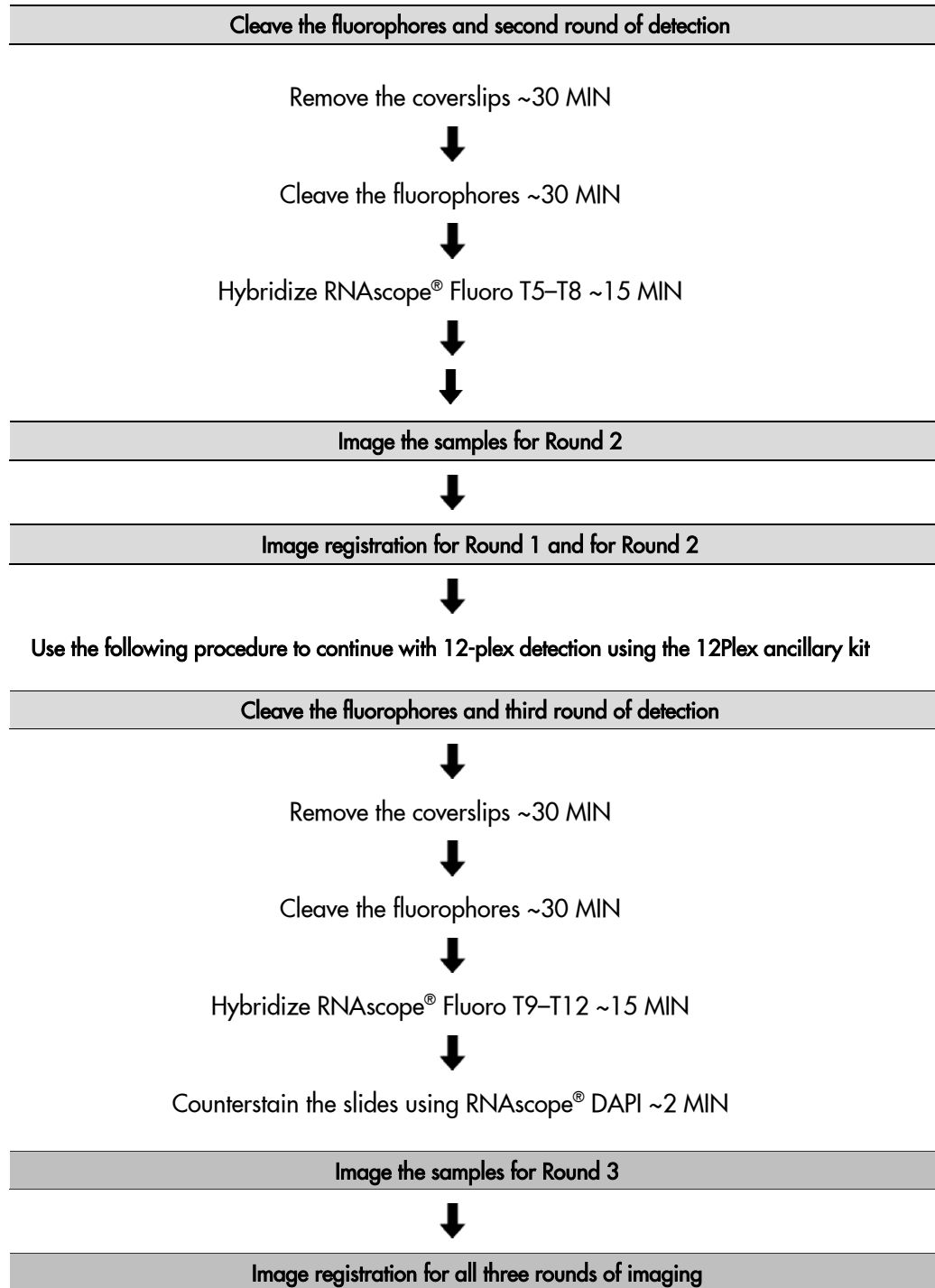



## Materials required for the assay

Materials provided by the RNAscope® HiPlex Detection Kits	Materials provided by the RNAscope® HiPlex Cleaving Kit	Materials provided by RNAscope® HiPlex Probes	Other materials and equipment
<ul style="list-style-type: none"> <li>• 50X Wash Buffer</li> <li>• RNAscope® HiPlex Amp 1</li> <li>• RNAscope® HiPlex Amp 2</li> <li>• RNAscope® HiPlex Amp 3</li> <li>• RNAscope® Fluoro T1–T4</li> <li>• RNAscope® Fluoro T5–8</li> <li>• RNAscope® Fluoro T9–T12 (optional)</li> <li>• RNAscope® DAPI</li> </ul>	<ul style="list-style-type: none"> <li>• Cleaving stock solution</li> </ul>	<ul style="list-style-type: none"> <li>• 50X RNAscope® HiPlex Target Probes</li> <li>• RNAscope® HiPlex Probe Diluent</li> <li>• RNAscope® HiPlex12 Positive Control Probe</li> <li>• RNAscope® HiPlex12 Negative Control Probe</li> </ul>	<ul style="list-style-type: none"> <li>• Prepared sections</li> <li>• Distilled water</li> <li>• 10X PBS</li> <li>• 20X SSC</li> <li>• 10% Tween</li> <li>• Carboy (&gt;3L)</li> <li>• Tissue-Tek® Staining Dish</li> <li>• HybEZ™ Humidifying System/RNAscope® EZ-Batch™ Slide Holder and Tray</li> <li>• Water bath or incubator</li> <li>• Tissue-Tek® Vertical 24 Slide Rack</li> <li>• Tubes (various sizes)</li> <li>• Paper towel or absorbent paper</li> <li>• ProLong Gold Antifade Mountant</li> <li>• Cover Glass, 24 mm x 50 mm</li> </ul>

## Prepare the materials

You may prepare the reagents at the same time you prepare pretreatment reagents. Refer to a sample preparation and pretreatment user guide available at [www.acdbio.com/technical-support/user-manuals](http://www.acdbio.com/technical-support/user-manuals).

Some of the materials may be prepared in advance and stored at room temperature.

### Prepare 1X Wash Buffer

- Prepare 3 L of 1X Wash Buffer by adding 2.94 L distilled water to 1 bottle of 50X Wash Buffer (60 mL) in a large carboy. Mix well.

**Note:** If precipitation occurs in the 50X Wash Buffer, warm it up at **40°C** for **10–20 MIN** before making the 1X Wash Buffer. 1X Wash Buffer may be prepared ahead of time and stored at room temperature for up to one month.

### Prepare 4X SSC

1. To prepare 4X SSC, dilute 20X SSC with distilled water by pipetting one volume of 20X SSC with four volumes of distilled water.
2. Mix thoroughly by inverting the container at least ten times.

**Note:** Prepare 20X SSC by dissolving 175.3 g of NaCl and 88.2 g of sodium citrate in 800 ml of distilled water and adjusting the pH to 7.0 with a few drops of 1M HCl. Use water to adjust the volume to 1 liter. Sterilize by autoclaving or filtering under vacuum.

### Prepare PBST (0.5% Tween)

1. To make 1-liter PBST (0.5% Tween), add 100 mL 10X PBS, 850 mL distilled water, and 50 mL of 10% Tween in a container. Scale up or down as needed.
2. Mix thoroughly by inverting the container at least ten times.

### Prepare probes

1. Warm RNAscope® HiPlex probe stocks at **40°C** in a water bath or incubator for about **10 MIN**.
2. Warm RNAscope® HiPlex diluent at **40°C** in a water bath or incubator for about **10 MIN**.
3. Briefly spin down all 50X probe stocks to collect the liquid at the bottom of the tubes.
4. Mix each unique target probe set by diluting 50X probe stocks with RNAscope® HiPlex probe diluent. Dilute probes to 1X by pipetting 1 volume of each stock to 50 volumes of probe diluent.
5. Mix well by vortexing or invert the tube several times.

**Note:** Do not mix probes of the same channel. The mixed probes can be stored at **2–8°C** for up to six months.

### Equilibrate reagents

- Place RNAscope® HiPlex Amp 1–3 and RNAscope® HiPlex Fluoro T1–T4 reagents at **RT**.
- Ensure that the HybEZ™ Oven and prepared Humidity Control Tray are at **40°C**.

## Run the assay

---

**Note:** Do **NOT** let sections dry out between incubation steps. Work *quickly* and fill barrier with solutions.

---

**Note:** View the wash step video at [www.acdbio.com/technical-support/learn-more](http://www.acdbio.com/technical-support/learn-more) before proceeding.

---

**Note:** We recommend running control probes on your sample and optimizing the protocol before running any target probes.

### Hybridize probe

---

**Note:** Ensure that the probes are prewarmed and cooled to **RT** prior to use.

1. Remove excess liquid from the slides while keeping the slides locked in the RNAscope® EZ-Batch™ Slide Holder. Insert the slide holder into HybEZ™ Humidity Control Tray
2. Add ~4 drops of the appropriate probe to entirely cover each section.

**Note:** Refer to **Appendix A. Reagent Volume Guidelines** on page 35 to determine the recommended number of drops needed per slide. For example, add 4 drops of the appropriate probe for a 0.75" x 0.75" barrier.

3. Close the tray and insert into the oven for **2 HRS** at **40°C**.
4. Pour at least 200 mL 1X Wash Buffer into the transparent RNAscope® EZ-Batch™ Wash Tray.
5. Remove the HybEZ™ Humidity Control Tray from the oven. Remove the slide holder from the tray. Place the tray back into the oven.
6. Place the RNAscope® EZ-Batch™ Slide Holder into the wash tray (see page 22 for details), and wash the slides for **2 MIN** at **RT**. Repeat the wash step with fresh buffer.

---

**Note:** **OPTIONAL STOPPING POINT.** You can store the slides in 5X SSC (not provided in the kit) overnight at **RT**. Before continuing with the assay, wash the slides twice with 1X Wash Buffer for **2 MIN** at **RT**.

---

## Hybridize RNAscope® HiPlex Amp 1

1. Remove excess liquid from the slides while keeping the slides locked in the RNAscope® EZ-Batch™ Slide Holder. Insert the slide holder into the HybEZ™ Humidity Control Tray.
2. Add ~4 drops of RNAscope® HiPlex Amp 1 to entirely cover each section.
3. Close the tray and insert into the HybEZ™ Oven for **30 MIN** at **40°C**.
4. Remove the HybEZ™ Humidity Control Tray from the oven. Remove the slide holder from the tray. Place the tray back into the oven.
5. Pour at least 200 mL 1X Wash Buffer into the transparent RNAscope® EZ-Batch™ Wash Tray.
6. Place the RNAscope® EZ-Batch™ Slide Holder into the wash tray (see page 22 for details), and wash the slides for **2 MIN** at **RT**. Repeat the wash step with fresh buffer.

## Hybridize RNAscope® HiPlex Amp 2

1. Remove excess liquid from the slides while keeping the slides locked in the RNAscope® EZ-Batch™ Slide Holder. Insert the slide holder into the HybEZ™ Humidity Control Tray.
2. Add ~4 drops of RNAscope® HiPlex Amp 2 to entirely cover each section.
3. Close the tray and insert into the HybEZ™ Oven for **30 MIN** at **40°C**.
4. Remove the HybEZ™ Humidity Control Tray from the oven. Remove the slide holder from the tray. Place the tray back into the oven.
5. Pour at least 200 mL 1X Wash Buffer into the transparent RNAscope® EZ-Batch™ Wash Tray.
6. Place the RNAscope® EZ-Batch™ Slide Holder into the wash tray (see page 22 for details), and wash the slides for **2 MIN** at **RT**. Repeat the wash step with fresh buffer.

## Hybridize RNAscope® HiPlex Amp 3

1. Remove excess liquid from the slides while keeping the slides locked in the RNAscope® EZ-Batch™ Slide Holder. Insert the slide holder into the HybEZ™ Humidity Control Tray.
2. Add ~4 drops of RNAscope® HiPlex Amp 3 to entirely cover each section.

3. Close the tray and insert into the HybEZ™ Oven for **30 MIN** at **40°C**.
4. Remove the HybEZ™ Humidity Control Tray from the oven. Remove the slide holder from the tray. Place the tray back into the oven.
5. Pour at least 200 mL 1X Wash Buffer into the transparent RNAscope® EZ-Batch™ Wash Tray.
6. Place the RNAscope® EZ-Batch™ Slide Holder into the wash tray (see page 22 for details), and wash the slides for **2 MIN** at **RT**. Repeat the wash step with fresh buffer.

## Hybridize RNAscope® HiPlex Fluoro T1–T4

1. Remove excess liquid from the slides while keeping the slides locked in the RNAscope® EZ-Batch™ Slide Holder. Insert the slide holder into the HybEZ™ Humidity Control Tray.
2. Add ~4 drops of RNAscope® HiPlex Fluoro T1–T4 to entirely cover each section.
3. Close the tray and insert into the HybEZ™ Oven for **15 MIN** at **40°C**.
4. Remove the tray from the oven, and remove the slide holder.
5. Pour at least 200 mL 1X Wash Buffer into the transparent RNAscope® EZ-Batch™ Wash Tray.
6. Place the RNAscope® EZ-Batch™ Slide Holder into the wash tray (see page 22 for details), and wash the slides for **2 MIN** at **RT**. Repeat the wash step with fresh buffer.

## Counterstain and mount the slides

---

**Note:** Do this procedure with no more than five slides at a time.

---

1. Remove excess liquid from the slides, and add ~4 drops of DAPI to each section.
2. Incubate for **30 SEC** at **RT**.
3. Remove DAPI from slides and *immediately* place 1–2 drops of the ProLong Gold Antifade Mountant onto each section.
4. Carefully place a coverslip over each tissue section. Avoid trapping air bubbles. Store slides in the dark at **2–8°C**.

---

**Note:** Use ProLong Gold Antifade Mountant as the mounting medium to best preserve the RNAscope® signals.

---



---

**Note:** Store slides in the dark at **2–8°C** before imaging. Do not leave slides at **RT** for more than **30 MIN**. Preventing the slides from completely drying will save time when you remove the coverslips.

---

## Image the slides for Round 1

1. Image the slides under a fluorescent microscope or fluorescent slide scanner.

**Note:** To make it easier to locate the same region of interest during the second round of image acquisition, use a microscope with a precise stage recorder. You will need filters for DAPI as well as the AF488, Atto550, Atto647N, and AF750 fluorophores.

2. As there will be two or three rounds of detection and imaging, we recommend including the initials R1 (round 1), R2 (round 2), R3 (round 3) and the target names when saving image files. Implementing a naming convention will help you identify each group of images during the image registration process.

3. Store the slides in the dark at **2–8°C** for up to three days, or proceed immediately to the fluorophore cleaving step.

## Equilibrate reagents

- Place RNAscope® HiPlex Fluoro T5–T8 reagent at **RT**.
- Ensure that the HybEZ™ Oven is at **40°C**.

## Cleave the fluorophores

1. To remove the coverslips:
  - a. Soak the slides in 4X SSC at **RT** for at least **30 MIN** or until the coverslips fall off the slides easily.
  - b. Gently remove each coverslip by pushing it horizontally.

---

**Note:** Do not use any buffer other than 4X SSC. To reduce tissue damage, do not remove the coverslips by force. Soak the slides in 4X SSC until the coverslips can be moved easily. If the slides have been dried completely, you may need to soak the slides in 4X SSC overnight.

---

2. Briefly wash the slides once in 4X SSC.
3. Break open a **FRESH** glass ampoule of provided cleaving stock solution.
4. Prepare a 10% cleaving solution by diluting with 4X SSC.

---

**Note:** Due to oxidation, do not use the cleaving stock solution more than once. Do not use any buffer other than 4X SSC to make 10% cleaving solution.

---

5. Load the slides in the RNAscope® EZ-Batch™ Slide Holder (see page 20 for details).
6. Remove excess liquid from the slides while keeping them locked in the RNAscope® EZ-Batch™ Slide Holder. Insert the slide holder into the HybEZ™ Humidity Control Tray.
7. Apply ~4 drops of freshly prepared 10% cleaving solution to entirely cover each section.
8. Close the tray and incubate for **15 MIN** at **RT**. Remove the slide holder from the tray.
9. Pour at least 200 mL PBST (0.5% Tween) into the transparent RNAscope® EZ-Batch™ Wash Tray.
10. Place the RNAscope® EZ-Batch™ Slide Holder into the wash tray (see page 22 for details), and wash the slides for **2 MIN** at **RT**. Repeat the wash step with PBST.

---

**Note:** Do not use any buffer other than PBST (0.5% Tween) for this step.

---

11. Repeat Steps 6–10 (10% cleaving solution incubation and PBST wash steps). When repeating Step 10, place the HybEZ™ Humidity Control Tray into the HybEZ™ Oven to warm the tray back up to **40°C**.

## Hybridize RNAscope® HiPlex Fluoro T5–T8

1. Remove excess liquid from the slides while keeping them locked in the RNAscope® EZ-Batch™ Slide Holder. Insert the slide holder into the HybEZ™ Humidity Control Tray.
2. Add ~4 drops of RNAscope® HiPlex Fluoro T5–T8 to entirely cover each section.
3. Close the tray and insert into the HybEZ™ Oven for **15 MIN** at **40°C**.
4. Remove the tray from the oven, and remove the slide holder from the tray.

5. Pour at least 200 mL 1X Wash Buffer into the transparent RNAscope® EZ-Batch™ Wash Tray.
6. Place the RNAscope® EZ-Batch™ Slide Holder into the wash tray (see page 22 for details), and wash the slides for **2 MIN** at **RT**. Repeat the wash step with fresh buffer.

## Mount the slides

---

**Note:** Do this procedure with no more than five slides at a time.

---

1. Remove excess liquid from the slides, and *immediately* place 1–2 drops of the Prolong Gold Antifade Mountant onto each section.
2. Carefully place a coverslip over each tissue section. Avoid trapping air bubbles. Store the slides in the dark at **2–8°C**.

## Image the slides for Round 2

1. Image the slides under a fluorescent microscope or fluorescent slide scanner.

**Note:** To make it easier to locate the same region of interest during the second round of image acquisition, use a microscope with a precise stage recorder. You will need filters for DAPI, as well as the AF488, Atto550, Atto647N, and AF750 fluorophores.

---

**Note:** Round 1 and Round 2 images require at least 70% overlap to be successfully registered using RNAscope® HiPlex Image Registration Software. Image registration uses nuclear staining, most commonly DAPI staining, as a reference. Adjust the exposure times to make sure that the nuclear signal matches the signals from Round 1 and Round 2 imaging.

---

2. As there will be two or three rounds of detection and imaging, we recommend including the initials R1 (round 1), R2 (round 2), R3 (round 3) and the target names when saving image files. Implementing a naming convention will help you identify each group of images during the image registration process.
3. Store the slides in the dark at **2–8°C** for up to three days, or proceed immediately to fluorophore cleaving.

## Image registration using RNAscope® HiPlex Registration Software

- Register the images generated from Round 1 and Round 2 using the single channel exposure.
- To ensure accuracy, make sure that the DAPI channel images are similarly exposed.
- Refer to the *RNAscope® HiPlex Registration Software User Manual* (300065-USM). A step by step guide for how to use the software is also available in the installer package of the software. If you have any questions, contact ACD technical support at [support.acd@bio-techne.com](mailto:support.acd@bio-techne.com).

## Continue with 12-plex detection using the 12Plex Ancillary Kit

### Cleave the fluorophores

1. To remove the coverslips:
  - c. Soak the slides in 4X SSC at **RT** for at least **30 MIN** or until the coverslips fall off the slides easily.

- d. Gently remove each coverslip by pushing it horizontally.

---

**Note:** Do not use any buffer other than 4X SSC. To reduce tissue damage, do not remove the coverslips by force. Soak the slides in 4X SSC until the coverslips can be moved easily. If the slides have been dried completely, you may need to soak the slides in 4X SSC overnight.

---

2. Briefly wash the slides once in 4X SSC.
3. Break open a **FRESH** glass ampoule of provided cleaving stock solution.
4. Prepare a 10% cleaving solution by diluting with 4X SSC.

---

**Note:** Due to oxidation, do not use the cleaving stock solution more than once. Do not use any buffer other than 4X SSC to make 10% cleaving solution.

---

5. Load the slides in the RNAscope® EZ-Batch™ Slide Holder (see page 20 for details).
6. Remove excess liquid from the slides while keeping them locked in the RNAscope® EZ-Batch™ Slide Holder. Insert the slide holder into the HybEZ™ Humidity Control Tray.
7. Apply ~4 drops of freshly prepared 10% cleaving to entirely cover each section.
8. Close the tray and incubate for **15 MIN** at **RT**. Remove the slide holder from the tray.
9. Pour at least 200 mL PBST (0.5% Tween) into the transparent RNAscope® EZ-Batch™ Wash Tray.
10. Place the RNAscope® EZ-Batch™ Slide Holder into the wash tray (see page 22 for details), and wash the slides for **2 MIN** at **RT**. Repeat the wash step with fresh buffer.

---

**Note:** Do not use any buffer other than PBST (0.5% Tween) for this step.

---

11. Repeat Steps 6–10 (10% cleaving solution incubation and PBST wash steps). When repeating Step 8, place the HybEZ™ Humidity Control Tray into the HybEZ™ Oven to warm the tray back up to **40°C**.

## Hybridize RNAscope® HiPlex Fluoro T9–T12

1. Remove excess liquid from the slides while keeping them locked in the RNAscope® EZ-Batch™ Slide Holder. Insert the slide holder into the HybEZ™ Humidity Control Tray.
2. Add ~4 drops of RNAscope® HiPlex Fluoro T9–T12 to entirely cover each section.
3. Close the tray and insert into the HybEZ™ Oven for **15 MIN** at **40°C**.
4. Remove the tray from the oven, and remove the slide holder from the tray.
5. Pour at least 200 mL 1X Wash Buffer into the transparent RNAscope® EZ-Batch™ Wash Tray.
6. Place the RNAscope® EZ-Batch™ Slide Holder into the wash tray (see page 22 for details), and wash the slides for **2 MIN** at **RT**. Repeat the wash step with fresh buffer.

## Counterstain and mount the slides

---

**Note:** Do this procedure with no more than five slides at a time.

---

1. Remove excess liquid from the slides, and add ~4 drops of DAPI to each section.
2. Incubate for **30 SEC** at **RT**.
3. Remove DAPI from the slides, and *immediately* place 1–2 drops of the ProLong Gold Antifade Mountant onto each section.

- Carefully place a coverslip over each tissue section. Avoid trapping air bubbles. Store the slides in the dark at **2–8°C**.

### Image the slides for Round 3

- Image the slides under a fluorescent microscope or fluorescent slide scanner.

**Note:** To make it easier to locate the same region of interest during the second round of image acquisition, use a microscope with a precise stage recorder. You will need filters for DAPI, as well as the AF488, Atto550, Atto647N, and AF750 fluorophores.

---

**Note:** Round 1 and Round 3 images require at least 70% overlap to be successfully registered using RNAscope® HiPlex Image Registration Software. Image registration uses nuclear staining, most commonly DAPI staining, as a reference. Adjust the exposure times to make sure that the nuclear signal matches the signals from Round 1 and Round 3 imaging.

---

- Store the slides in the dark at **2–8°C**.

### Image registration using RNAscope® HiPlex Registration Software

- Register the images generated from Round 1 and Round 3 using the single channel exposure.
- To ensure accuracy, make sure that the DAPI channel images are similarly exposed.
- Refer to the *RNAscope® HiPlex Registration Software User Manual* (Doc. No. 300065-USM). A step by step guide for how to use the software is also available in the installer package of the software. If you have any questions, contact ACD technical support at [support.acd@bio-techne.com](mailto:support.acd@bio-techne.com).



## Evaluate the samples

For an example of successful staining, see **Figure 2** on page 34. Examine tissue sections under a standard fluorescent microscope at 20–40X magnification. You can also use a confocal microscope.

- Assess tissue and cell morphology.
- Assess the positive control signal strength. Positive control signal should be visible as punctuate dots within a cell at 20X magnification.
- Assess the negative control background. Five dots in every 10 cells displaying background staining per microscope field is acceptable at 20X magnification.
- Evaluate the target probe signal using the scoring guidelines in the next section.

## Fluorescent Imaging Recommendations

Here are a few fluorescent imaging recommendations:

Viewing	Detection	Microscope	Optics
<ul style="list-style-type: none"> <li>• Image capture is the recommended digital capturing option</li> <li>• Fluorescence viewing is the recommended viewing option</li> </ul>	<ul style="list-style-type: none"> <li>• Microscope with camera and fluorescence options. Multispectrum microscope/camera system recommended (eg. Nuance FX)</li> <li>• Fluorescence detection requires a high resolution and high sensitivity cooled CCD camera that is 64 <math>\mu\text{m}</math> pixel size or smaller with &gt; 65% peak quantum efficiency</li> <li>• Common models include: Orca-Flash 4.0 (Hamamatsu), and Nuance FX (Nuance)</li> </ul>	<ul style="list-style-type: none"> <li>• Leica DM series or equivalent</li> <li>• Zeiss Axio Imager or equivalent</li> <li>• Inverted microscope is okay if optics and condenser meet requirements</li> </ul>	<ul style="list-style-type: none"> <li>• 20X (N.A. 0.75) air, 40X (N.A. 0.8) air, 40X (N.A. 1.3) oil, 63X (N.A. 1.3) oil, and 100X (N.A. 1.4) oil</li> <li>• 20X and 40X objective can be used for visualization of high expression genes and low expression genes, respectively</li> </ul>

## Control example

Figure 2 is an example of RNA expression in the striatum region of a normal mouse brain.

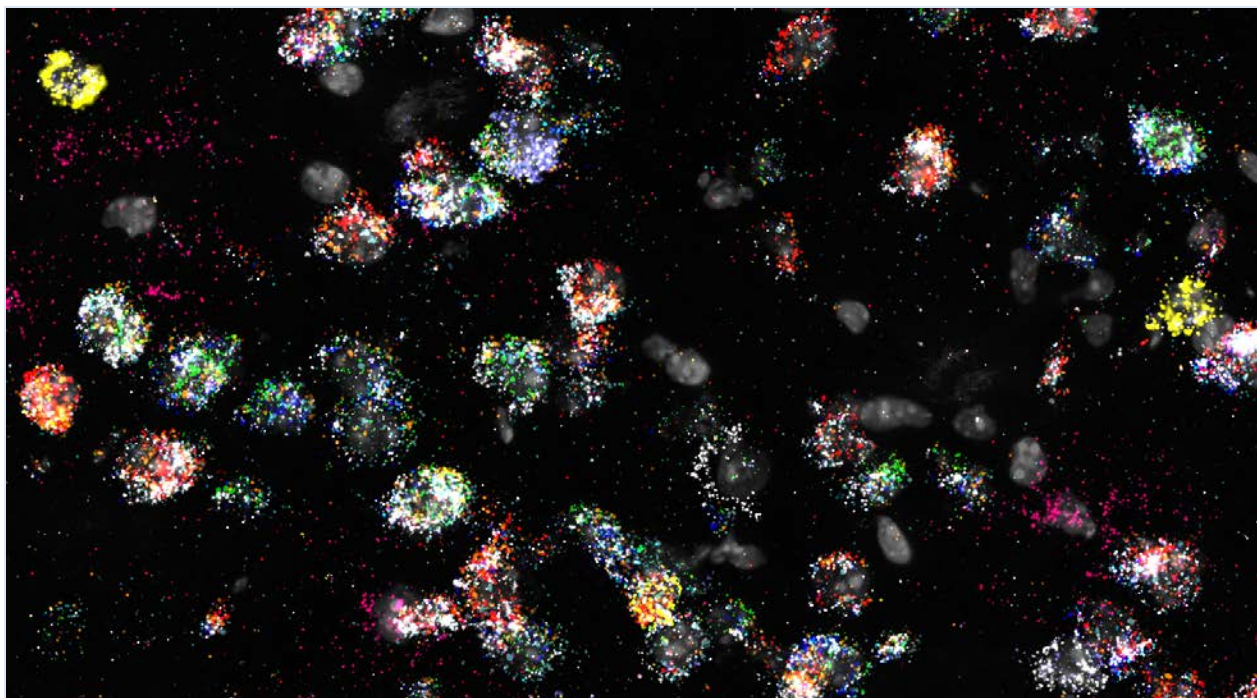

**Figure 2.** Visualizing striatal *Drd1a* and *Drd2* Medium Spiny Neurons (MSNs) using the RNAscope® HiPlex Assay for 12 targets in fresh frozen mouse brain sections. Targets are *Drd1a*, *Drd2*, *Foxp1*, *Pcdh8*, *Synpr* (in white), *Htr7*, *Meis2*, *Calb1*, *Crym*, *Cnr1*, *Wfs1*, *Th* (in yellow).

## Troubleshooting



For troubleshooting information, please contact technical support at [support.acd@bio-techne.com](mailto:support.acd@bio-techne.com).

# A

## Appendix A. Reagent Volume Guidelines

### Determine reagent volume

Before starting your experiment, measure the inner edge of the hydrophobic barrier to determine the recommended number of drops needed per slide (see table below).

Size of hydrophobic barrier* (in)	Recommended number of drops per slide	Recommended volume per slide (µL)	Relative template size
0.75" x 0.75" †	4	120	
0.75" x 1.0"	5	150	
0.75" x 1.25"	6	180	

\* Hydrophobic barrier measured at inner edge. References in this user manual are for the 0.75" x 0.75" hydrophobic barrier size.

† Recommended hydrophobic barrier size is 0.75" x 0.75". With this barrier size, each probe is sufficient for staining ~20 sections. Larger tissue sections will result in fewer tests.

# B

## Appendix B. Manual Target Retrieval

### Materials required

Materials provided by the Universal Pretreatment Kit	Other Materials and Equipment
<ul style="list-style-type: none"> <li>• RNAscope® 10X Target Retrieval Reagents</li> </ul>	<ul style="list-style-type: none"> <li>• Prepared slides</li> <li>• Distilled water</li> <li>• Glass beaker (1 or 2 L)</li> <li>• Paper towel or absorbent paper</li> <li>• Hot plate, isotemp brand</li> <li>• Aluminum foil</li> <li>• Thermometer</li> <li>• Forceps, large</li> <li>• Tissue Tek® Slide Rack</li> <li>• Tissue Tek® Staining Dish</li> <li>• ImmEdge™ Hydrophobic Barrier Pen</li> </ul>

### Prepare 1X RNAscope® Target Retrieval Reagents

**IMPORTANT!** Do not boil the 1X RNAscope® Target Retrieval Reagents more than **15 MIN** before use.

1. Prepare 700 mL of fresh RNAscope® 1X Target Retrieval Reagents by adding 630 mL distilled water to 1 bottle (70 mL) 10X Target Retrieval Reagents in the beaker. Mix well.
2. Place the beaker containing RNAscope® 1X Target Retrieval Reagents on the hot plate. Cover the beaker with foil, and turn the hot plate on high for **10–15 MIN**.
3. Once the 1X RNAscope® Target Retrieval Reagents reach a mild boil (**98–102°C**), turn the hot plate to a lower setting to maintain the correct temperature. Check the temperature with a thermometer.

### Apply RNAscope® Target Retrieval Reagents

1. With a pair of forceps *very slowly* submerge the slide rack containing the slides into the mildly boiling RNAscope® 1X Target Retrieval Reagents solution. Cover the beaker with foil, and boil the slides for the amount of time specified by the table in **Appendix A. Tissue Pretreatment Recommendation** on page 35.
2. Use the forceps to *immediately* transfer the hot slide rack from the RNAscope® 1X Target Retrieval Reagents to the staining dish containing distilled water. Do not let the slides cool in the Target Retrieval Reagents solution.
3. Wash slides 3–5 times by moving the Tissue-Tek® Slide Rack up and down in the distilled water.
4. Wash slides in fresh 100% alcohol, and allow the slides to dry completely at 60 °C for 5 MIN.
5. Draw the hydrophobic barrier, and continue with RNAscope® HiPlex Assay.



# Appendix B. Safety

## Chemical safety



**WARNING!** GENERAL CHEMICAL HANDLING. To minimize hazards, ensure laboratory personnel read and practice the general safety guidelines for chemical usage, storage, and waste provided below, and consult the relevant SDS for specific precautions and instructions:

- Read and understand the Safety Data Sheets (SDSs) provided before you store, handle, or work with any chemicals or hazardous materials. To obtain SDSs, visit <http://www.acdbio.com/technical-support/user-manuals>.
- Minimize contact with chemicals. Wear appropriate personal protective equipment when handling chemicals (for example, safety glasses, gloves, or protective clothing).
- Minimize the inhalation of chemicals. Do not leave chemical containers open. Use only with adequate ventilation (for example, fume hood).
- Characterize (by analysis if necessary) the waste generated by the particular applications, reagents, and substrates used in your laboratory.
- Ensure that the waste is stored, transferred, transported, and disposed of according to all local, state/provincial, and/or national regulations.
- **IMPORTANT!** Radioactive or biohazardous materials may require special handling, and disposal limitations may apply.

## Biological hazard safety



**WARNING!** BIOHAZARD. Biological samples such as tissues, body fluids, infectious agents, and blood of humans and other animals have the potential to transmit infectious diseases. Follow all applicable local, state/provincial, and/or national regulations. Wear appropriate protective equipment, which includes but is not limited to: protective eyewear, face shield, clothing/lab coat, and gloves. All work should be conducted in properly equipped facilities using the appropriate safety equipment (for example, physical containment devices). Individuals should be trained according to applicable regulatory and company/institution requirements before working with potentially infectious materials. Read and follow the applicable guidelines and/or regulatory requirements in the following:

### In the U.S.:

- U.S. Department of Health and Human Services guidelines published in Biosafety in Microbiological and Biomedical Laboratories found at [www.cdc.gov/biosafety](http://www.cdc.gov/biosafety)
- Occupational Safety and Health Standards, Bloodborne Pathogens (29 CFR§1910.1030)
- Your company's/institution's Biosafety Program protocols for working with/handling potentially infectious materials
- Additional information about biohazard guidelines is available at [www.cdc.gov/](http://www.cdc.gov/)

### In the EU:

- Check local guidelines and legislation on biohazard and biosafety precaution and refer to the best practices published in the World Health Organization (WHO) Laboratory Biosafety Manual, third edition
- Registration, Evaluation, Authorisation and Restriction of Chemicals (REACH)

# Documentation and support

## Obtaining SDSs

Safety Data Sheets (SDSs) are available at: [www.acdbio.com/technical-support/user-manuals](http://www.acdbio.com/technical-support/user-manuals). For the SDSs of chemicals not distributed by Advanced Cell Diagnostics, contact the chemical manufacturer.

## Obtaining support

For the latest services and support information, go to: [www.acdbio.com/technical-support/support-overview](http://www.acdbio.com/technical-support/support-overview).

At the website, you can:

- Access telephone and fax numbers to contact Technical Support and Sales facilities.
- Search through frequently asked questions (FAQs).
- Submit a question directly to Technical Support.
- Search for user documents, MSDSs, application notes, citations, training videos, and other product support documents.
- Find out information about customer training events.

## Contact information

Advanced Cell Diagnostics, Inc.  
7707 Gateway Boulevard  
Newark, CA 94560  
Toll Free: 1-877-576-3636  
Direct: 1-510-576-8800  
Fax: 1-510-576-8801  
Information: [info.acd@bio-techne.com](mailto:info.acd@bio-techne.com)  
Orders: [order.acd@bio-techne.com](mailto:order.acd@bio-techne.com)  
Support Email: [support.acd@bio-techne.com](mailto:support.acd@bio-techne.com)

## Limited product warranty

Advanced Cell Diagnostics, Inc. and/or its affiliate(s) warrant their products as set forth in the ACD General Terms and Conditions of Sale found on the ADC website at [www.acdbio.com/store/terms](http://www.acdbio.com/store/terms). If you have any questions, please contact Advanced Cell Diagnostics at [www.acdbio.com/about/contact](http://www.acdbio.com/about/contact).

**Headquarters**

7707 Gateway Blvd, Newark, CA 94560 Phone 1-510-576-8800 Toll Free 1-877-576-3636

For support, email [support.acd@bio-techne.com](mailto:support.acd@bio-techne.com).

[www.acdbio.com](http://www.acdbio.com)

